

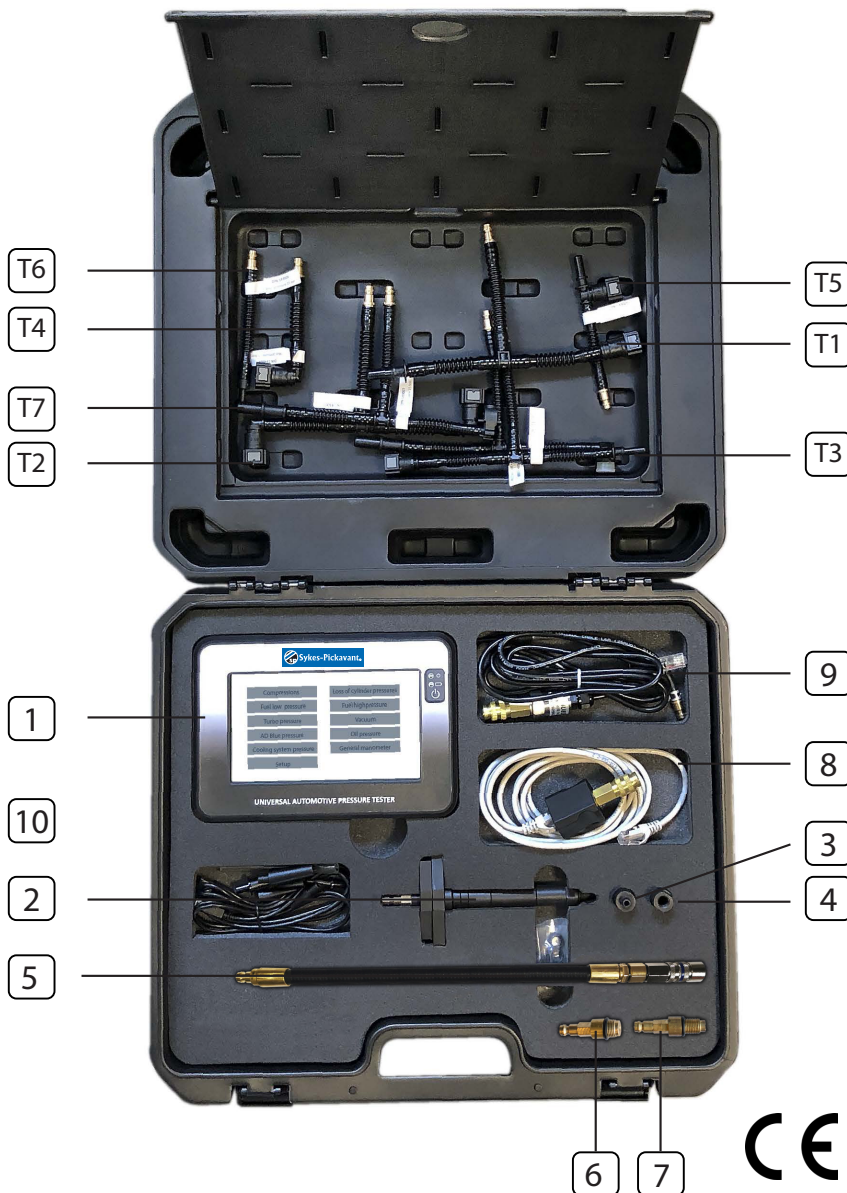

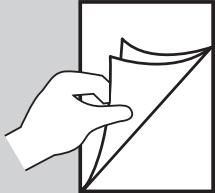







UNIVERSAL DIGITAL PRESSURE TESTER

sp 33100000

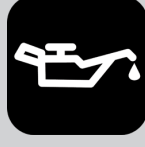
- GB** Universal Digital Pressure Tester
- FR** Testeur de pression digital universel
- DE** Universeller digitaler Druckprüfer
- SP** Probador de presión digital universal
- IT** Tester di pressione digitale universale
- PT** Verificador Universal de Pressão Digital
- NL** Universele digitale druktester



					
I		page 1	VI		page 8
II		page 3	VII		page 9
	Gasoline		VIII		page 10
III		page 4	IX		page 11
	Diesel		X		page 12
IV		page 6	XI		page 13
	Gasoline				
V		page 7			
	Diesel				





1

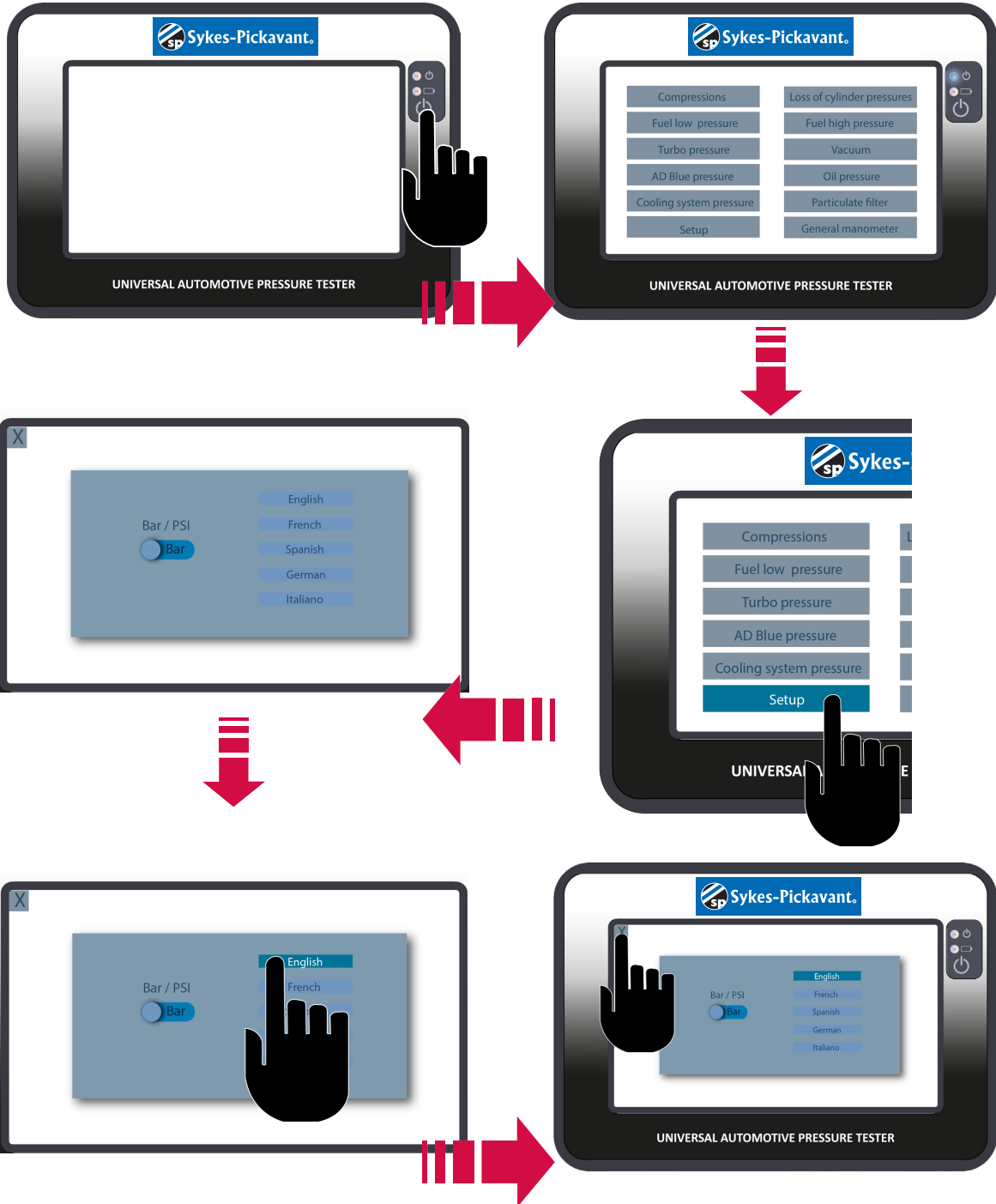

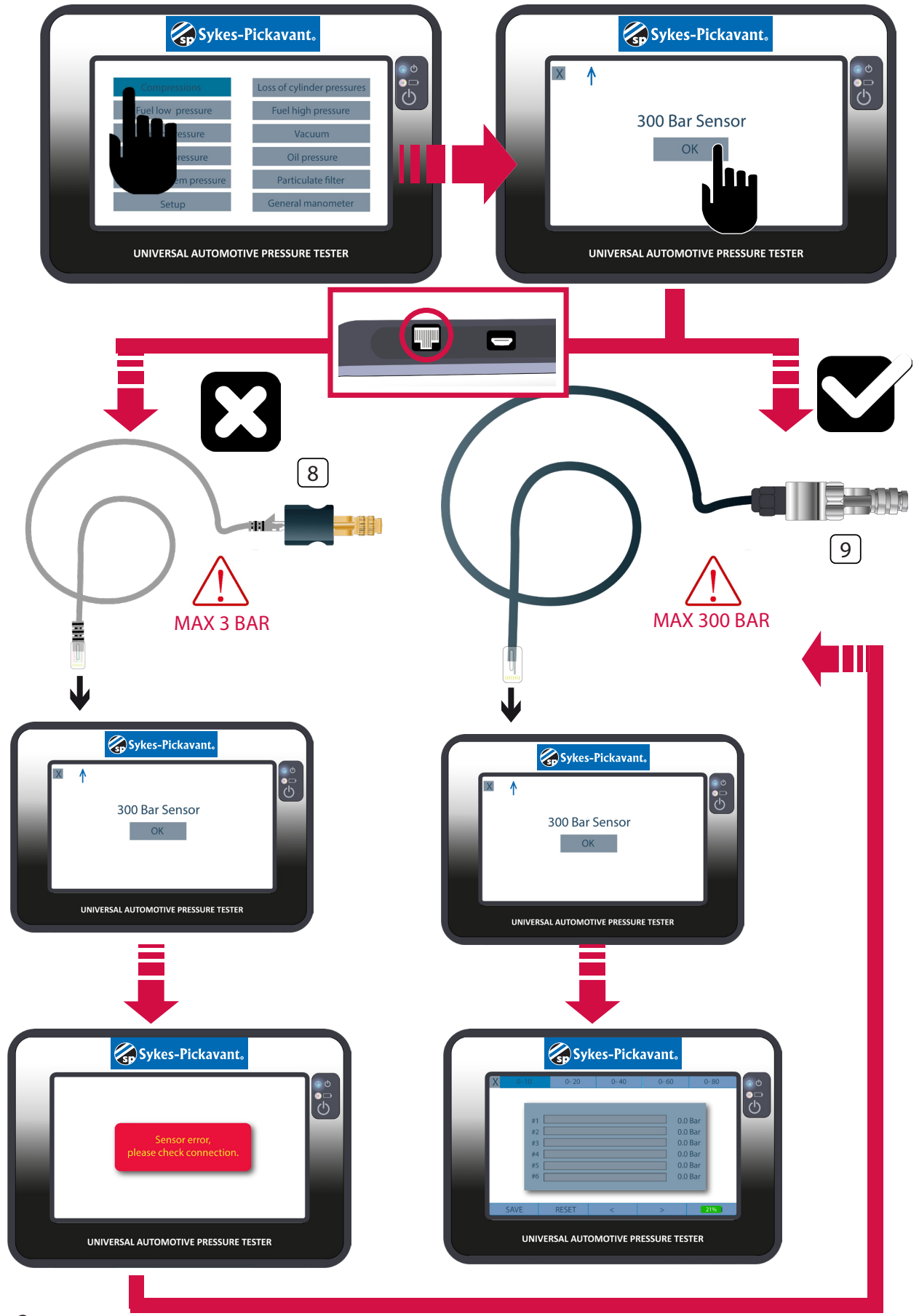

II

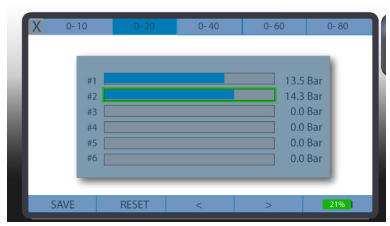
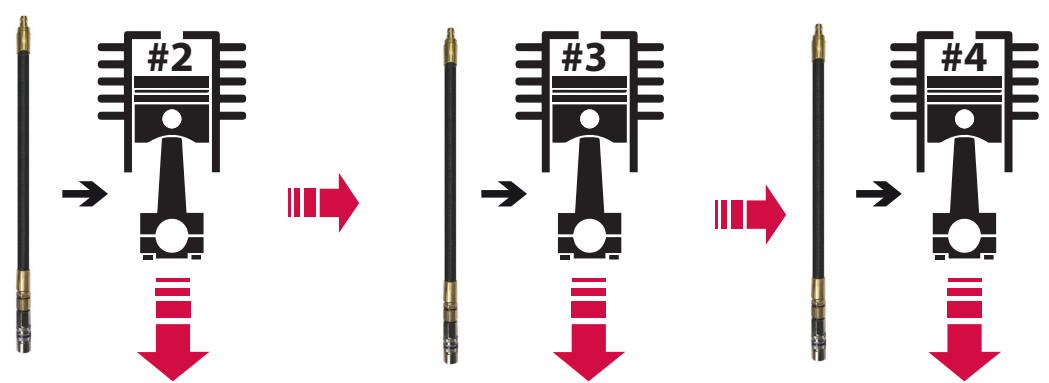
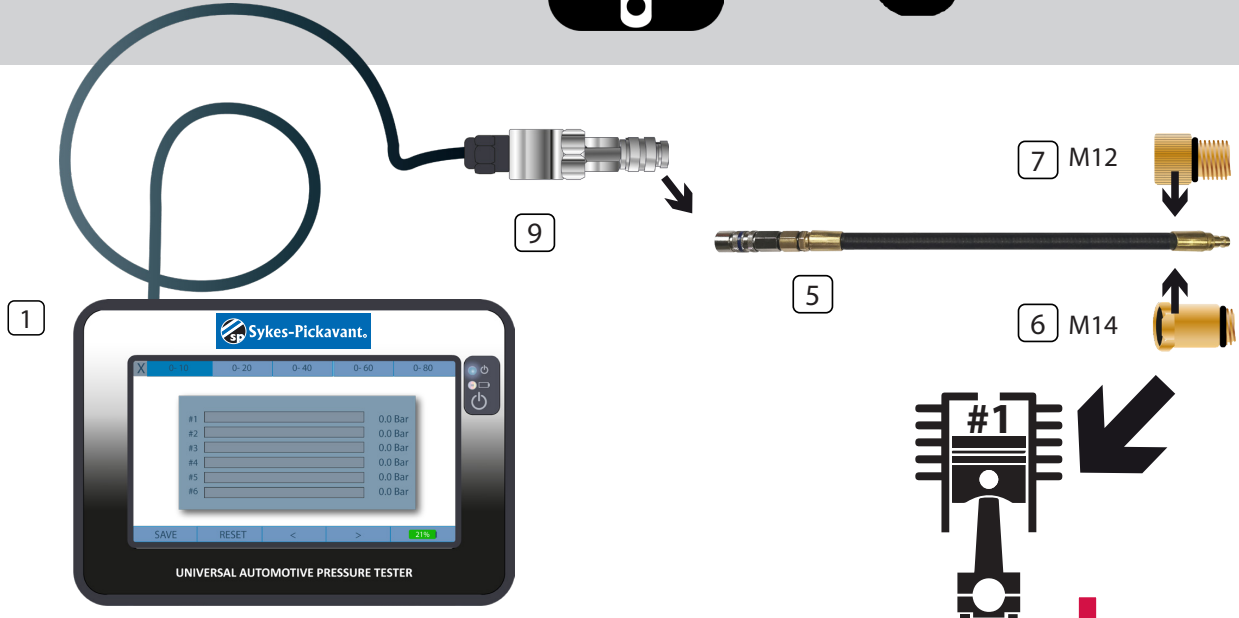

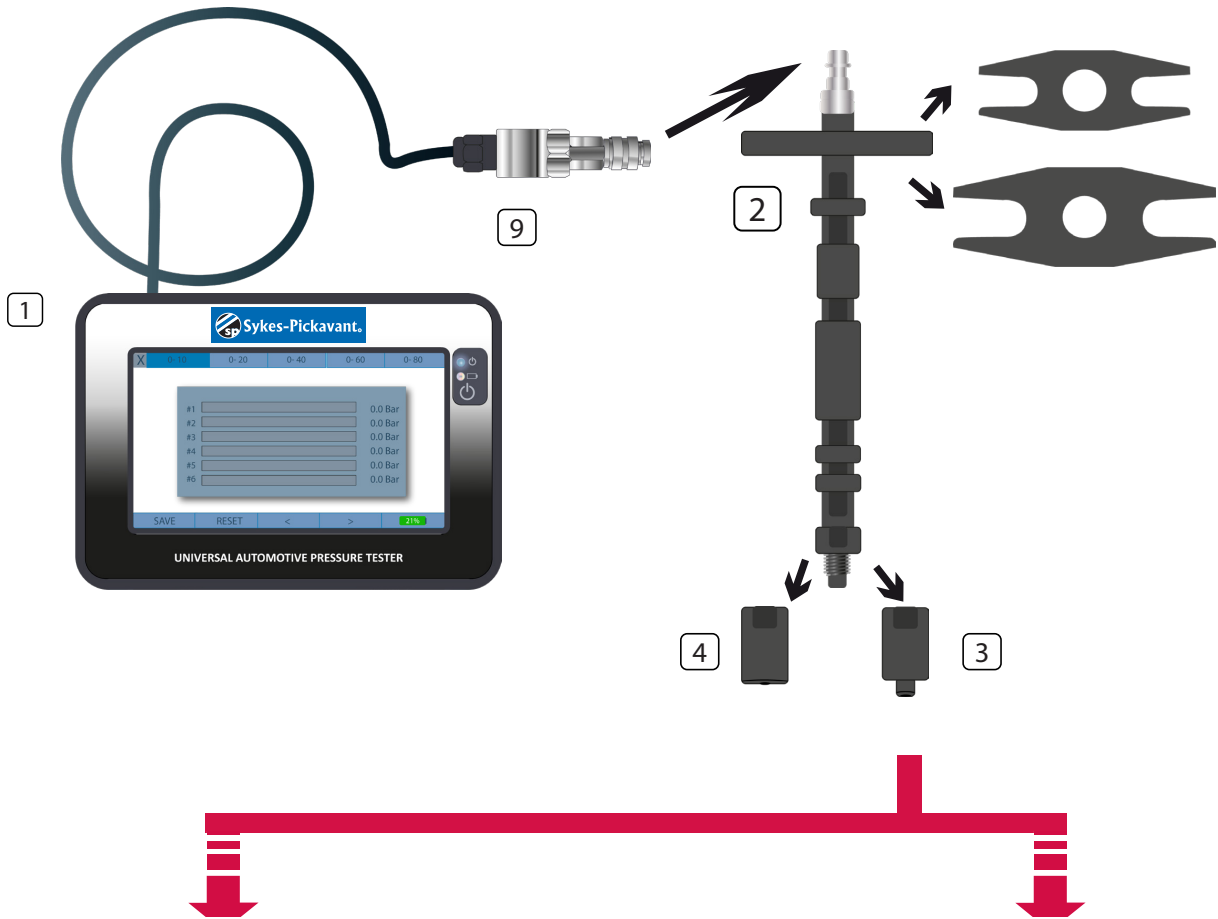
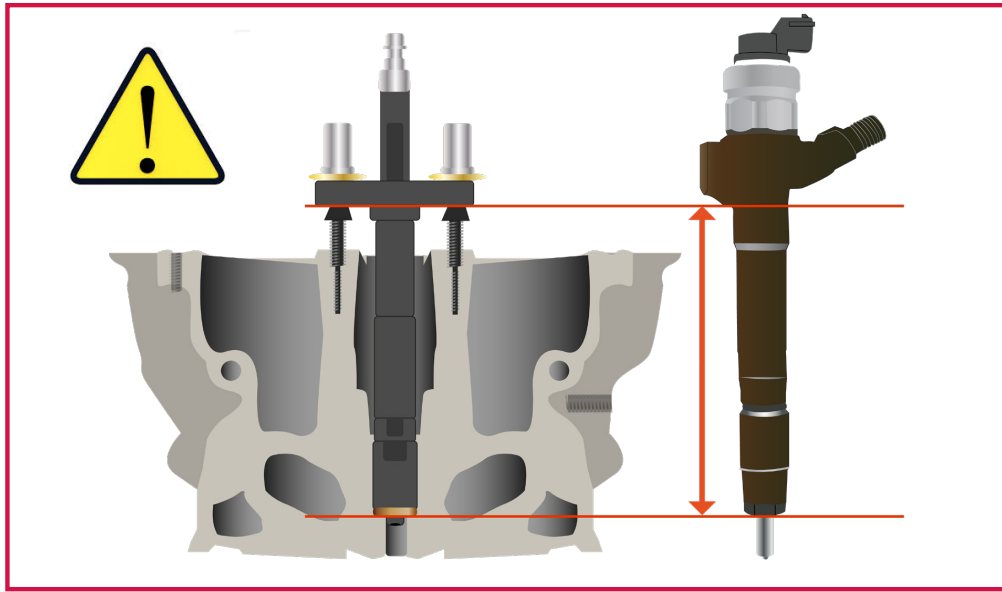

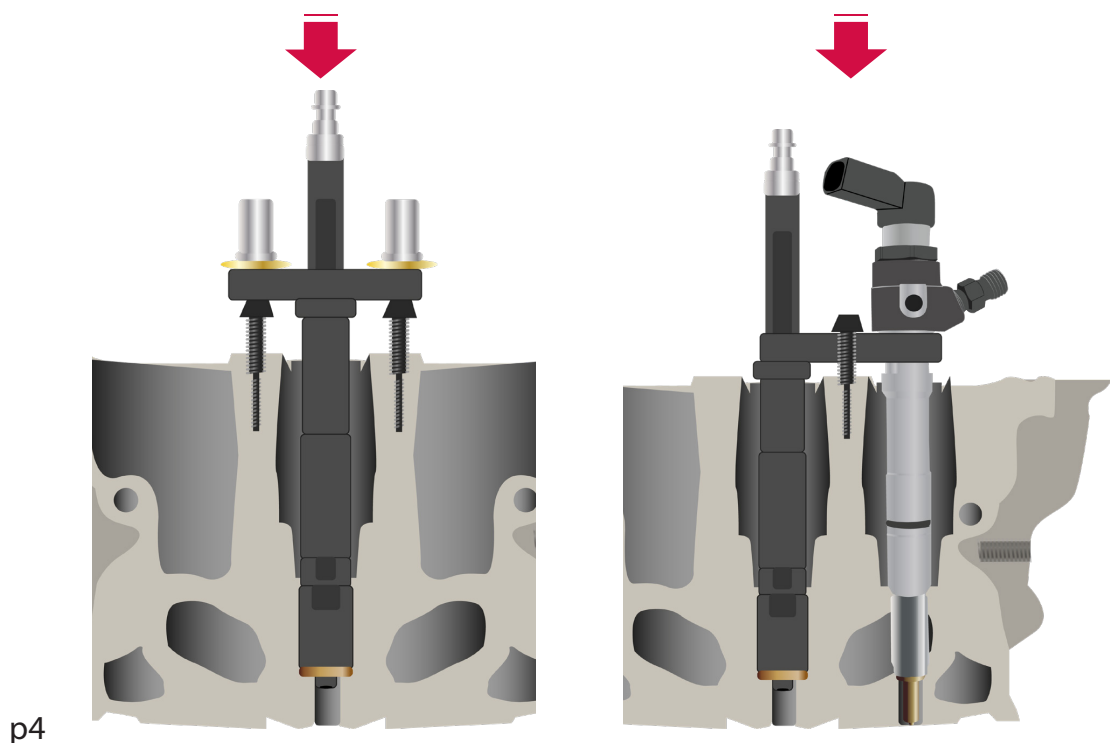

p4

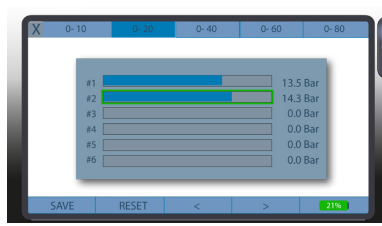
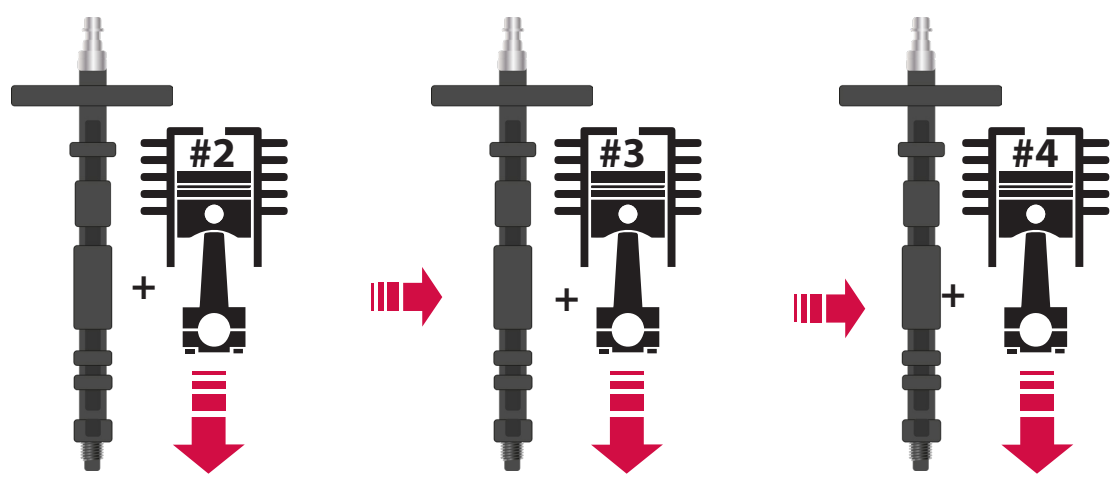

p5

IV



Gasoline
Diesel

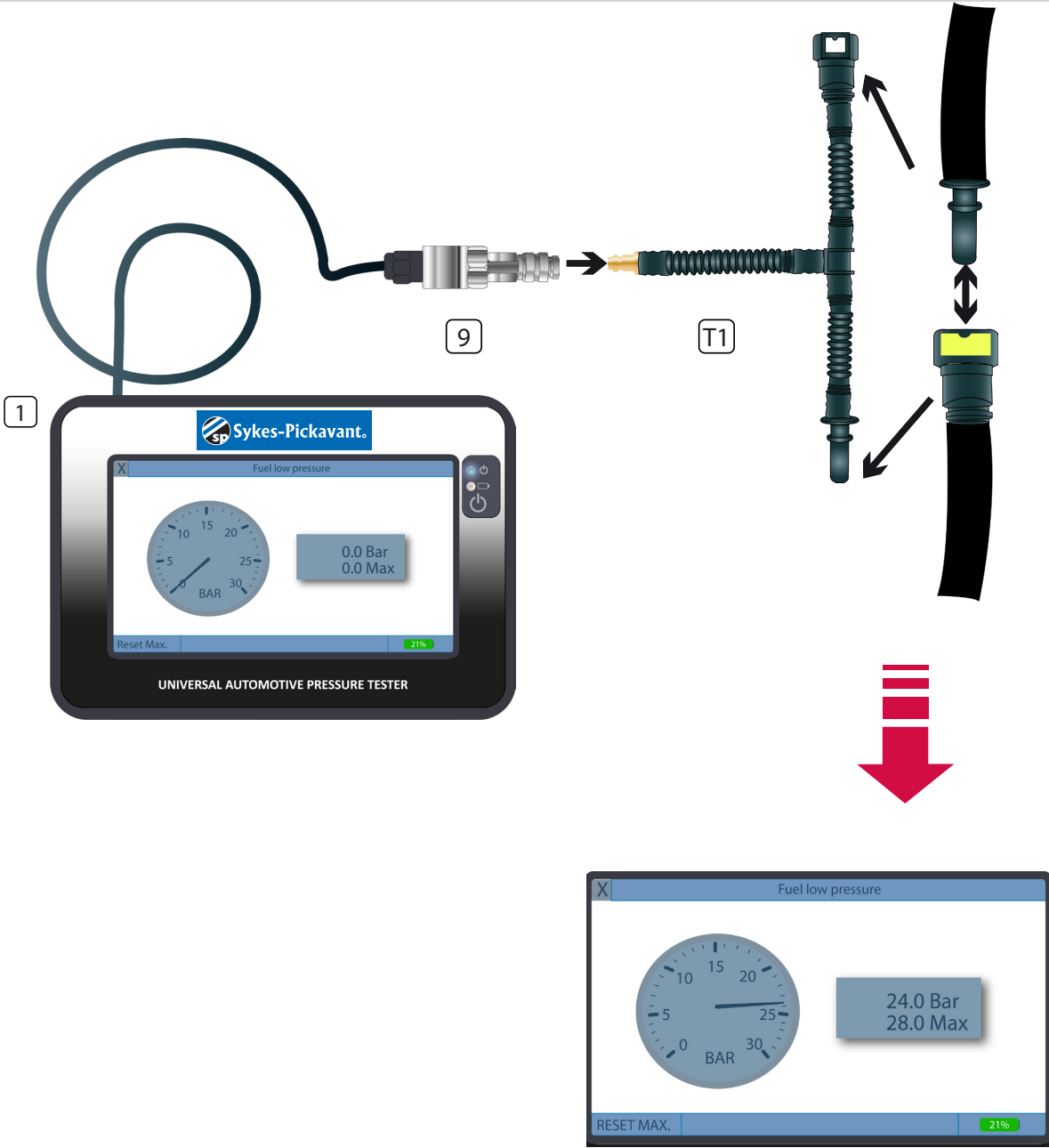

V



Turbo pressure

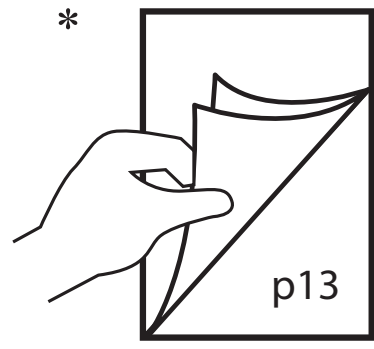
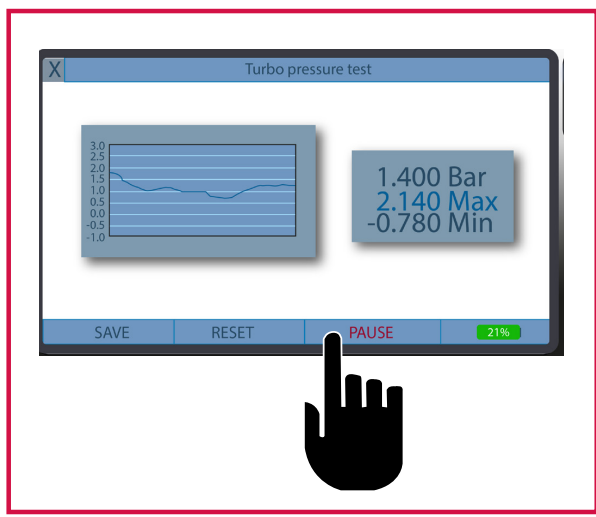
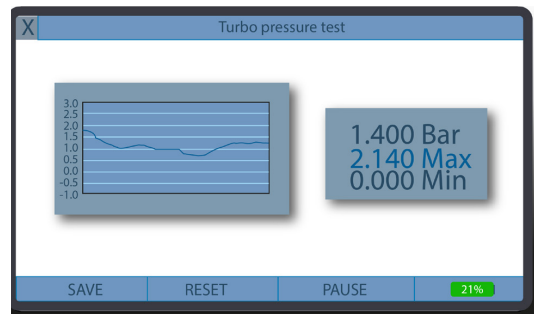
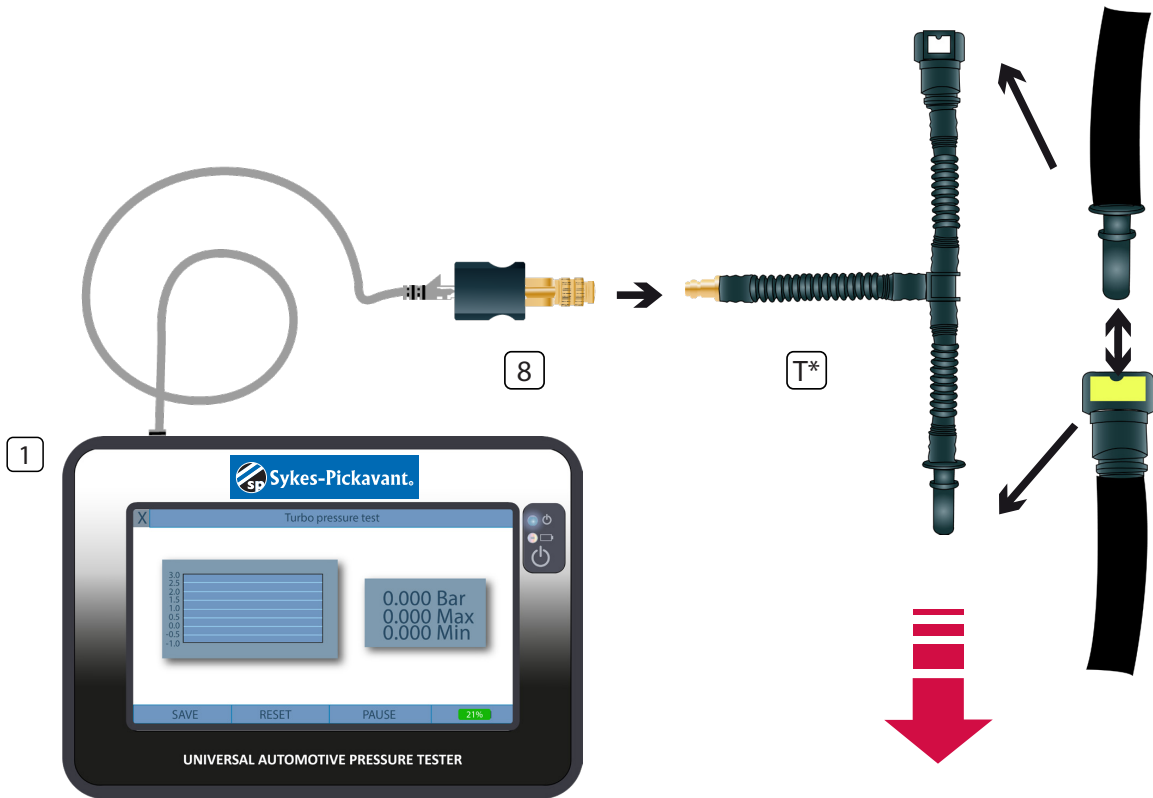

VI

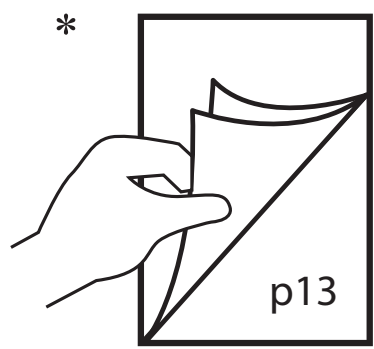
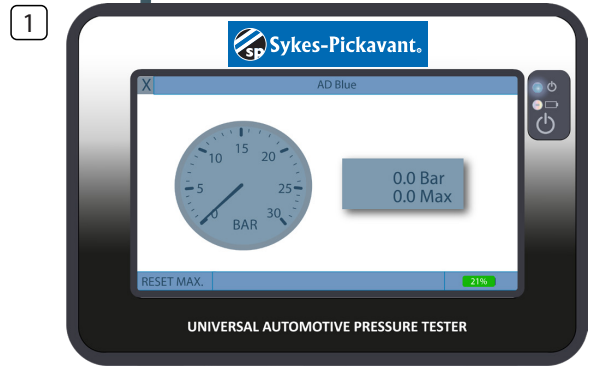
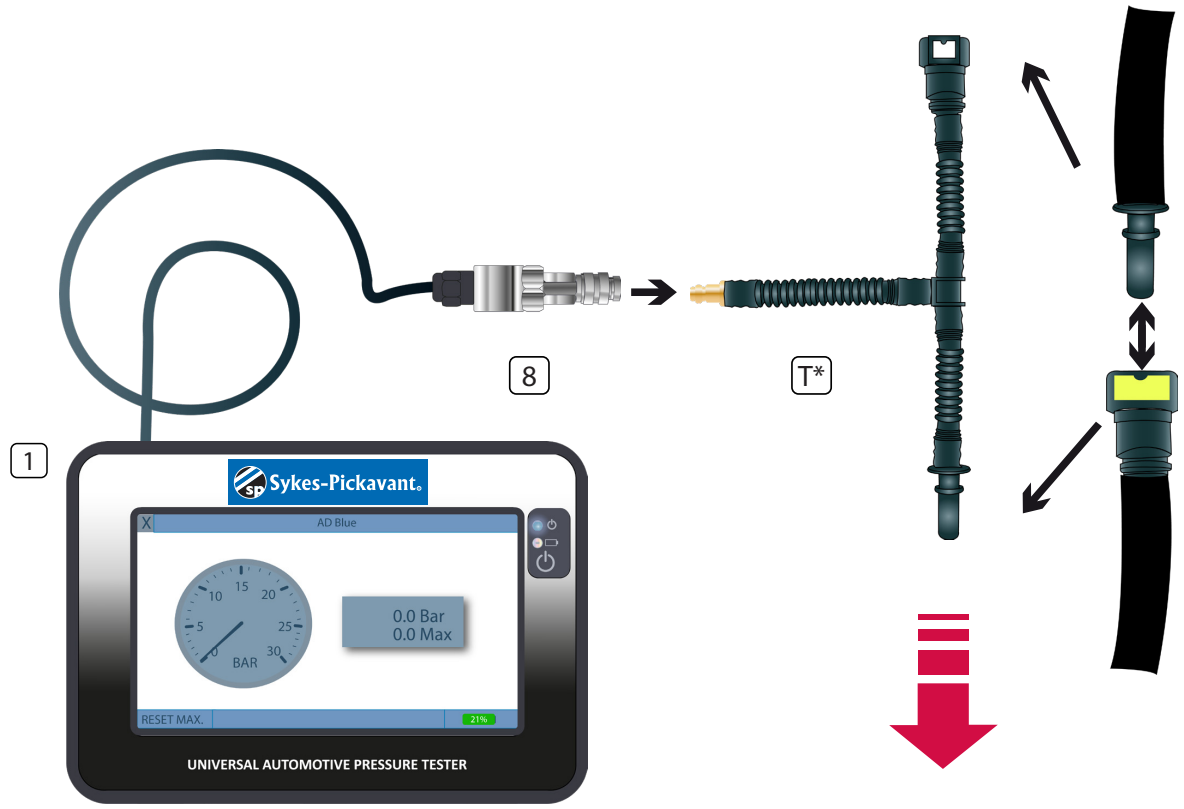

p8

VII

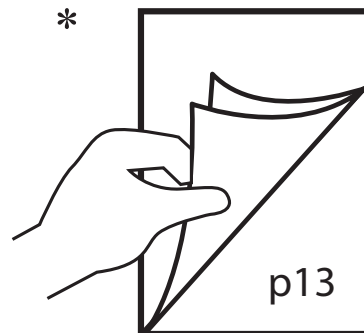
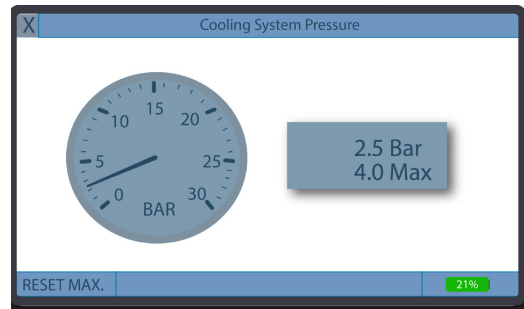
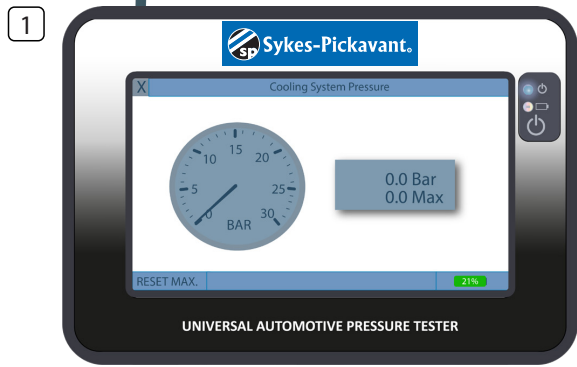
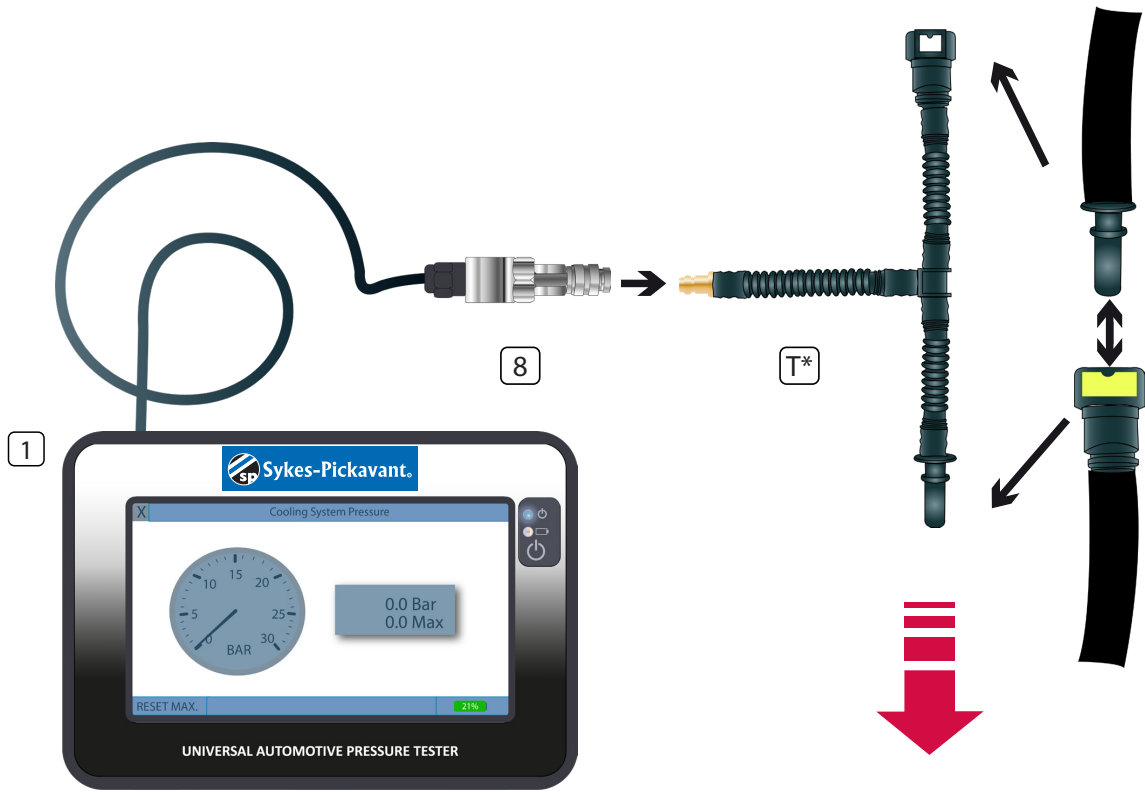
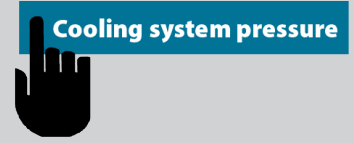

VIII

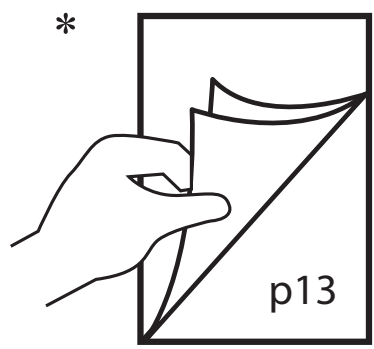
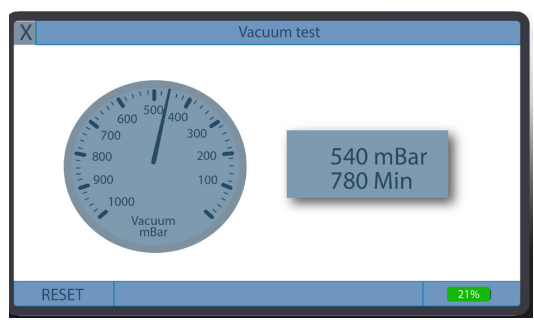
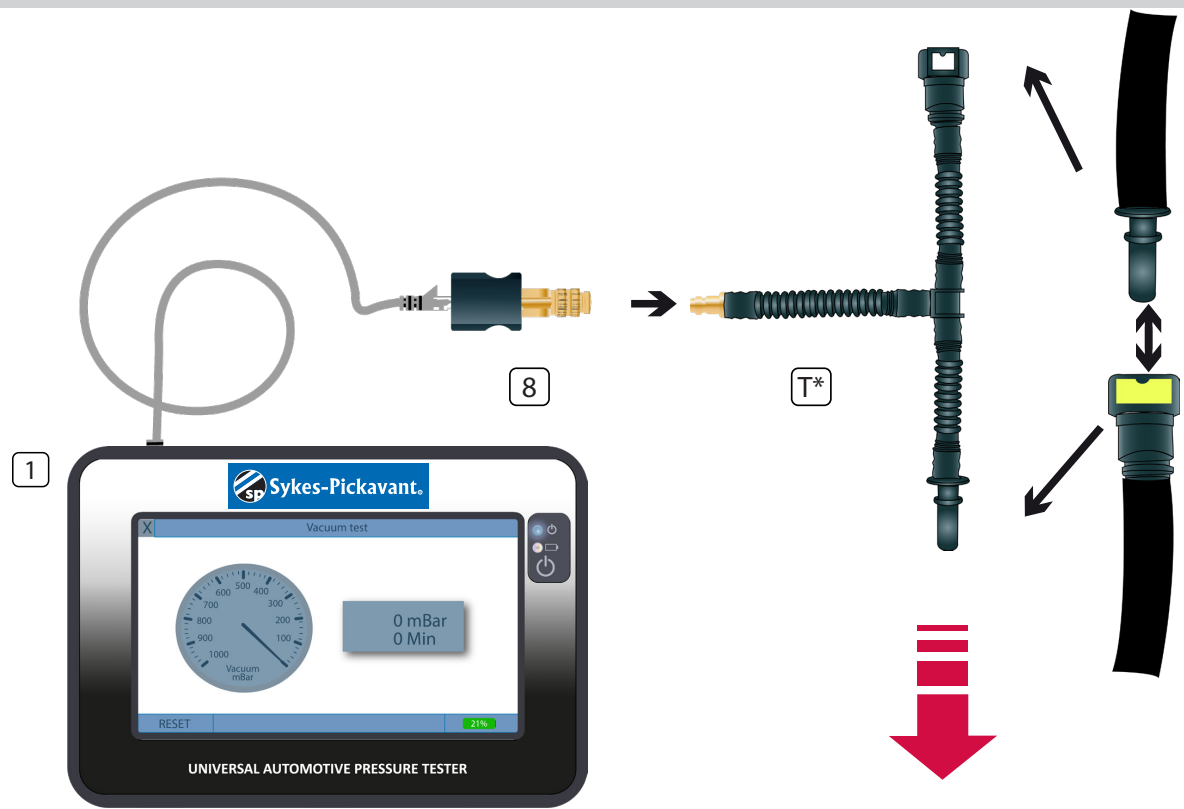

p10

IX

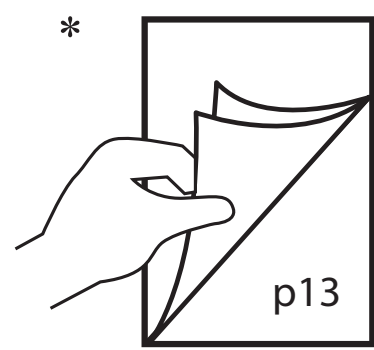
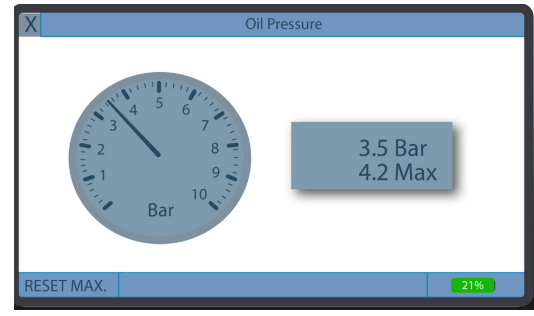
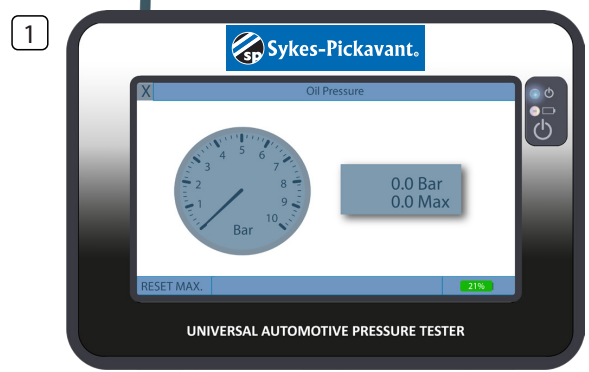
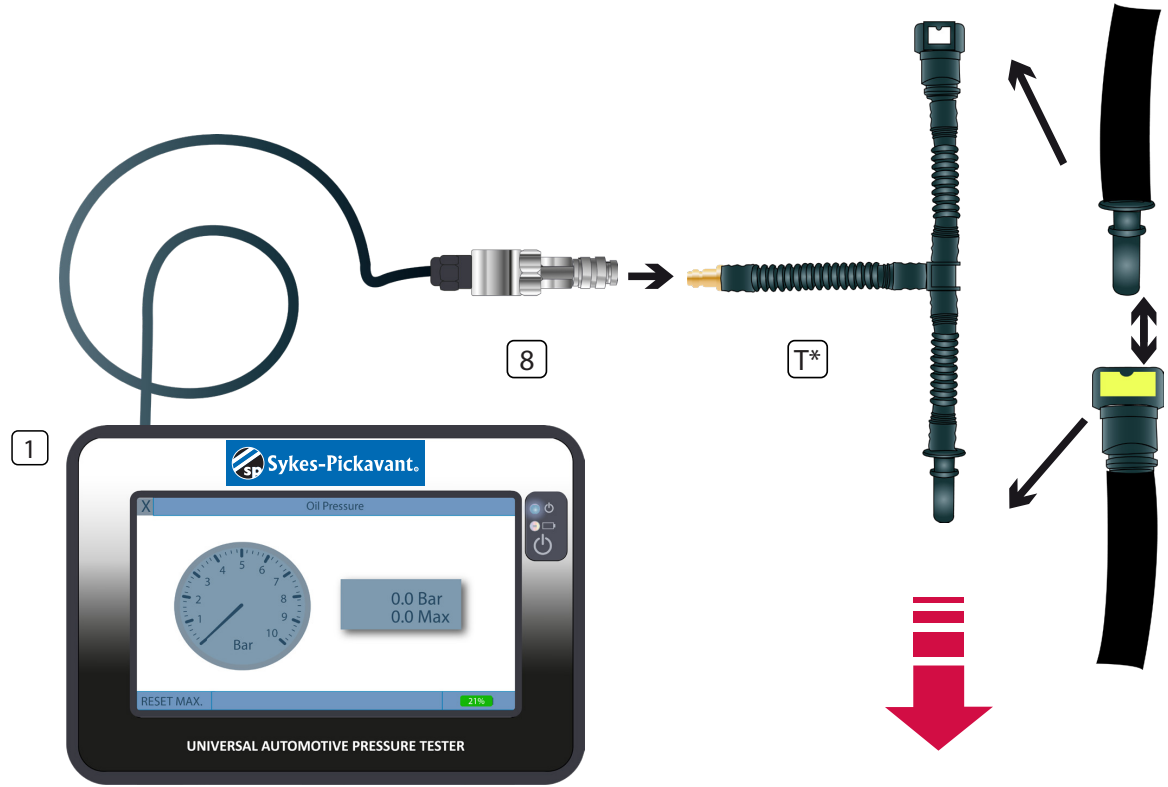
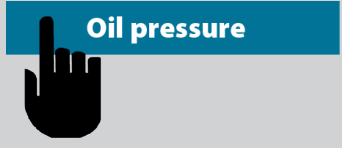

X

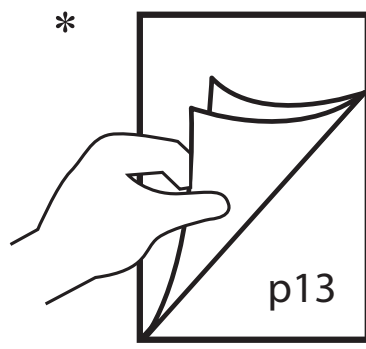
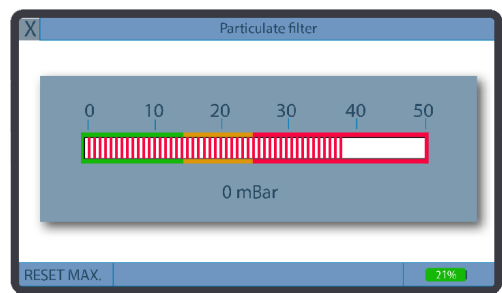
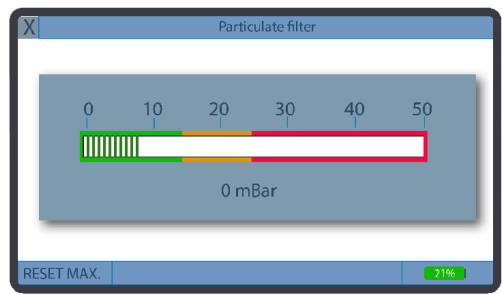
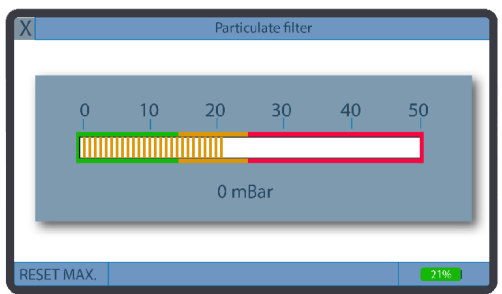
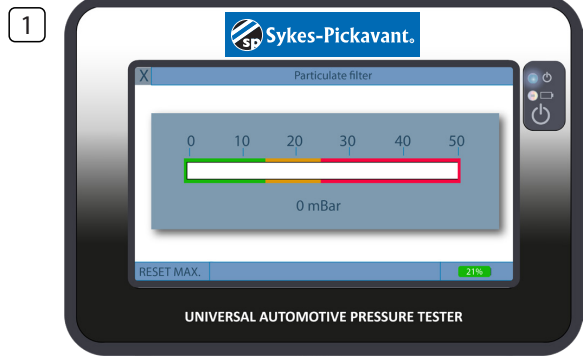
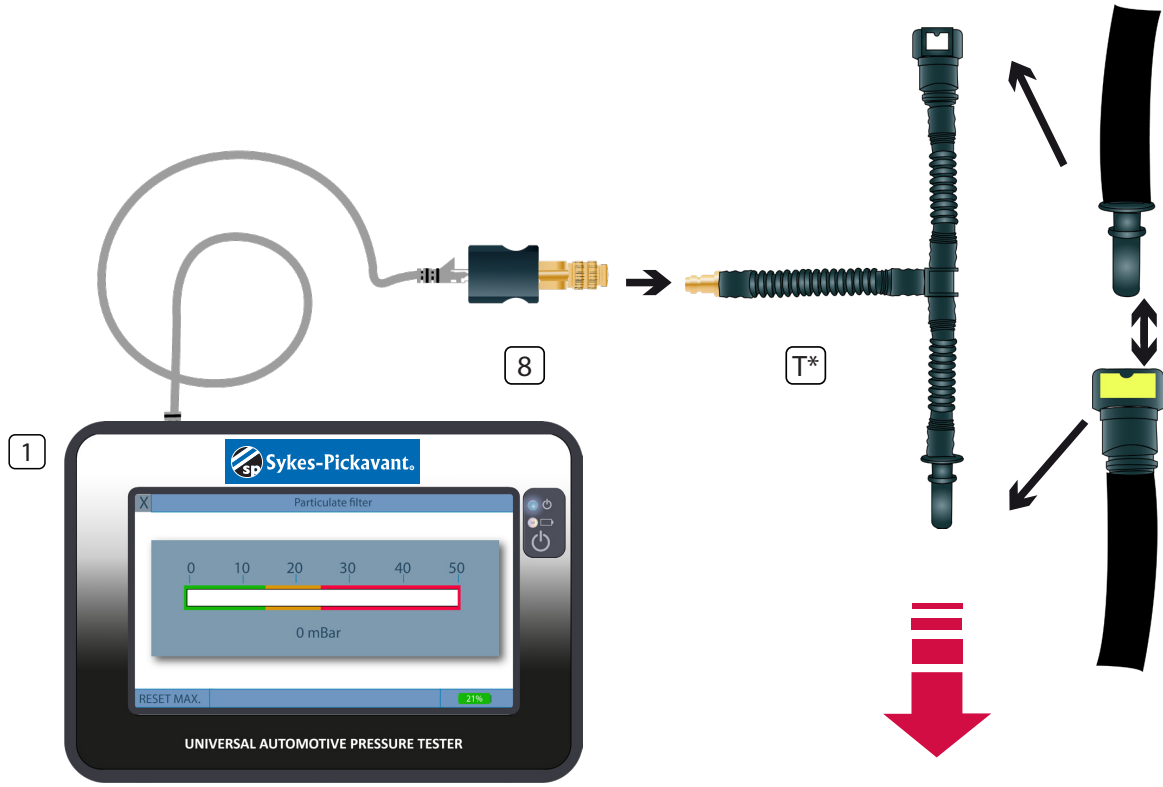

p12

XI



T1

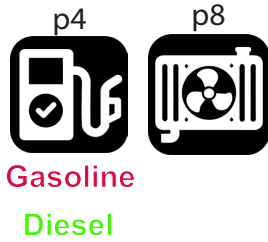
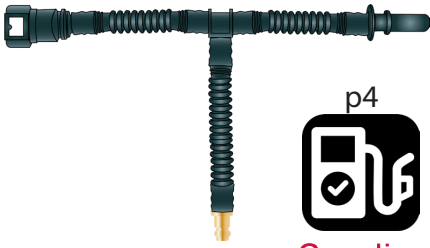

T2

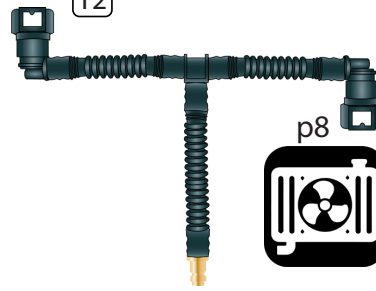

T3

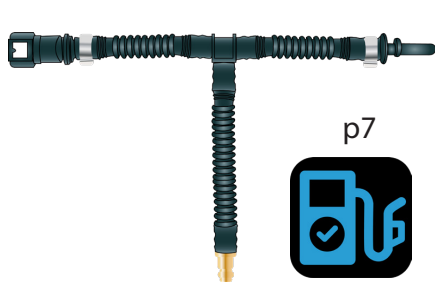

T4

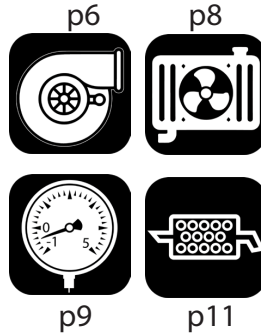

T5

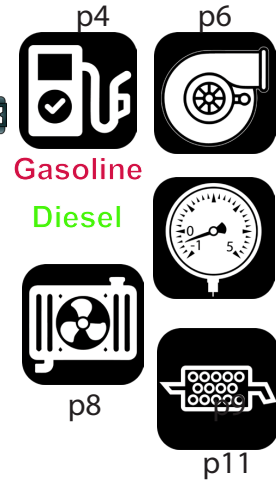

T6



T7

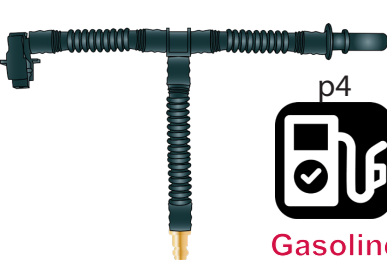

T8

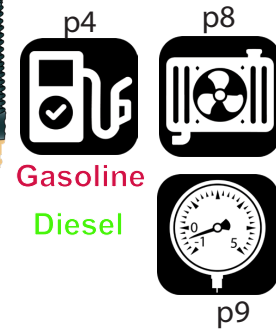

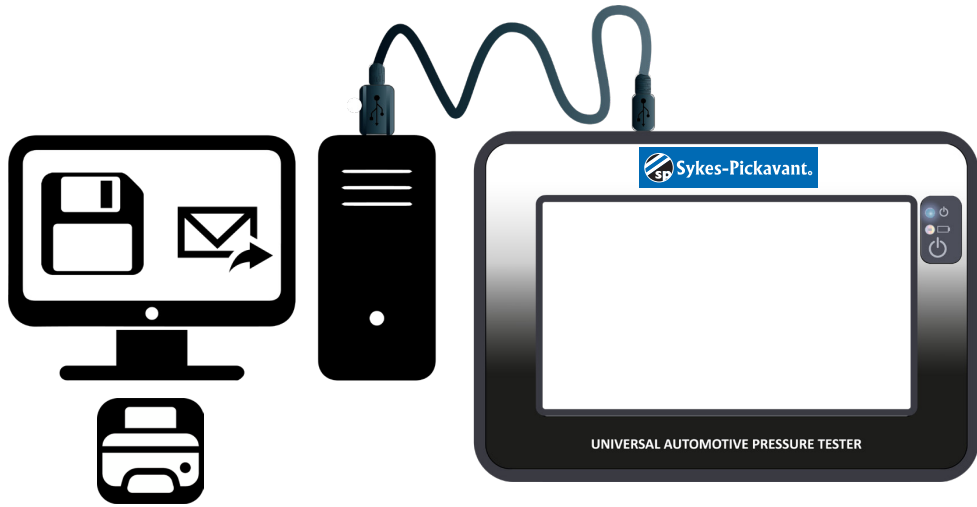
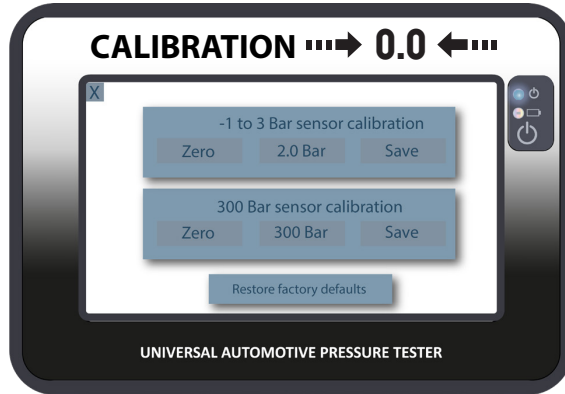

<http://universalpressuretester.com/software.exe>

